



Instruction manual



2026-05-28

**Rack conveyor dishwasher 270, cold water, right exit, heat recovery system, for osmotic water
XT 270 R Z Y**

www.rmgastro.com



TABLE OF CONTENTS

1. DECLARATION OF CONFORMITY	3
2. TECHNICAL DATA	3
3. LOCATION ELECTRIC	3
4. SAFETY MEASURES FOR FIRE PROTECTION	3
5. INSTALLATION	4
6. WATER CONNECTION	4
7. CONNECTING THE ELECTRICAL CABLE TO THE NETWORK	4
8. INSTRUCTIONS FOR USE	9
9. CLEANING AND MAINTENANCE	24

1. DECLARATION OF CONFORMITY

Decree of the Ministry of Health of the Czech Republic no. 38/2001 Coll. of 19 January 2001 Regulation (EC) No 1907/2006 - Registration, Evaluation, Authorisation and Restriction of Chemicals (REACH) Regulation of the European Parliament and Council Regulation (EC) no. 1935/2004 of 27 October 2004

The products meet the requirements of §26 of Act No.258/2000 as amended. The products meet the requirements of RoHS Directive 2015/863/EU, 10/2011, 517/2014, 2015/1094, 2015/1095.

Attention, the manufacturer gives up any responsibility in case of direct and indirect damage that is related to poor installation, incorrect intervention or adjustments, insufficient maintenance, incorrect use and which are eventually caused by other causes than the points referred to in the conditions of sale. This appliance is intended only for professional use and must be operated by qualified persons. Parts that have been secured by the manufacturer or authorized worker after the setting rebuild.

2. TECHNICAL DATA

The label with technical data is located on the side or back panel of the device. Please read the wiring diagram and all the following information in the attached manual before installation.

Net Width [mm]	Net Depth [mm]	Net Height [mm]	Net Weight [kg]
3406	1615	1615	640.00
Power electric [kW]	Loading	Basin volume [l]	
44.100	400 V / 3N - 50 Hz	70	

3. LOCATION ELECTRIC

For the correct operation and placement of the appliance, it is necessary to observe the following all prescribed standards for the given market. Unpack the device and check that the device has not been damaged during transport. Place the device on a horizontal surface (maximum unevenness up to 2°). Small unevenness can be leveled with adjustable feet. If the device will be placed in such a way that it will be in contact with the walls of the furniture, these must withstand a temperature of up to 60°C. Installation, adjustment, commissioning must be performed by a qualified person who is authorized to perform such operations, according to applicable standards. The device can be installed separately or in series with devices of our production. A minimum distance of 10 cm from flammable materials must be observed. In this case, it is necessary to secure the appropriate modifications to ensure the thermal insulation of the combustible parts. The appliance must only be installed on a non-flammable surface or against a non-flammable wall. **Parts of the appliance provided by the manufacturer. or his representative, the worker performing the installation may not rebuild the product.**

4. SAFETY MEASURES FOR FIRE PROTECTION

- the appliance may only be operated by adults
- the appliance may be used safely in accordance with applicable market standards:

Fire protection in spaces with special risk or danger

Protection against the effects of heat

- the appliance must be placed so that it stands or hangs firmly on a non-combustible surface

Objects of flammable substances must not be placed on the appliance at a distance less than a safe distance from it (the smallest distance between the appliance and flammable substances is 10 cm).

Table: degree of flammability of building materials included in st. flammability of substances and products

Degree of flammability	Building materials
A - non-flammable	granite, sandstone, concrete, brick, ceramic tiles, plaster
B - Not easily flammable	Acumin, Heraclitus, Lihnos, Itaver

Degree of flammability	Building materials
C1 - highly flammable	wood, hardwood, plywood, hard paper, umakart
C2 - moderately flammable	chipboards, solodur, cork boards, rubber, flooring
C3 - Highly flammable	wood fiber boards, polystyrene, polyurethane, PVC

- information on the degree of flammability of common building materials is given in the table above. Appliances must be installed in a safe manner. During installation, the relevant design, safety and hygiene regulations must also be respected:
- fire safety of local appliances and heat sources
- fire protection in areas with special risk or danger
- protection against the effects of heat

5. INSTALLATION

Important: The manufacturer does not provide any warranty for defects arising as a result of incorrect use, failure to follow the instructions contained in the attached user manual and mishandling of appliances. Installation, modification and repair of appliances for large kitchens, as well as their dismantling due to possible damage to the gas supply, can only be carried out on the basis of a maintenance contract, this contract can be concluded with an authorized dealer, while technical regulations and standards and regulations must be observed regarding installation, electrical supply, gas connection and work safety. Technical instructions for installation and adjustment, for use by specialized technicians ONLY. The instructions that follow refer to a technician qualified for installation to carry out all operations in the most correct manner and according to the applicable standards. Any activity related to regulation etc. must only be performed with the device disconnected from the network. If it is necessary to keep the appliance under voltage, the utmost care must be taken. The type of appliance for extraction is declared on the nameplate, it is an A1 appliance.

6. WATER CONNECTION

Water connection is done using G1/2 threaded hoses. The water supply must be fitted with separate closures that are freely accessible and within reach of the device. The device includes return valves. The water for filling the duplicator space must be softened - a maximum of 5 ° the French scale of water hardness. The water pressure must be in the range of 50-300 kPa.

7. CONNECTING THE ELECTRICAL CABLE TO THE NETWORK

Installation of the electrical supply - this supply must be separately secured. Ato with the corresponding circuit breaker of rated current depending on the power input of the installed device. Check the power consumption of the device on the production label on the back panel (or side) of the device. The connected ground wire must be longer than the other wires. Connect the device directly to the network, it is necessary to insert a switch between the device and the device with a minimum distance of 3 mm between the individual contacts, which corresponds to the applicable standards and load. The earth supply (yellow-green) must not be interrupted by this switch. Connect the device to the mains if the socket has adequate protection. In any case, the supply cable must be located so that it does not reach a temperature of 50 degrees higher than the environment at any point. Before the appliance is connected to the network, it is necessary to first make sure that:

- the supply circuit breaker and the internal distribution can withstand the current load of the appliance (see matrix label)
- the distribution board is equipped with effective grounding according to the standards of the relevant market and the conditions given by law
- the socket or switch in the supply is easily accessible from the appliance
- the electrical supply to the device must be made of oil-resistant material

We disclaim any responsibility in the event that these standards are not respected and in the event of

a violation of the above principles. Before first use, you must clean the device, see chapter "cleaning and maintenance". The appliance must be grounded using a screw with a grounding mark.

- Do not insert the plug of the power supply into the electrical outlet. sockets and do not pull out the zel. sockets with wet hands and pulling on the power cord!
- Do not use extension cords or multiple sockets.
- **The mains connection point must have a maximum of the following impedance: $Z_{MAX} = 0.042 + j 0.026 \Omega$ for the phase conductors and $0.028 + j 0.017 \Omega$ for the neutral conductor.**

Connection to the power grid

Attention! Installation must only be carried out by specialist technicians!

- Before connecting the appliance, make sure that the rated voltage and frequency of the mains power supply correspond to the values indicated on the type plate of the appliance, located on the side panel of the appliance.
- To connect the appliance to the mains, use only cables of type H07RN-F with a conductor cross-section suitable for the maximum power rating indicated on the type plate, as shown in the following table.
- Take care to pull the cables with the minimum bending radius specified by the cable manufacturer.

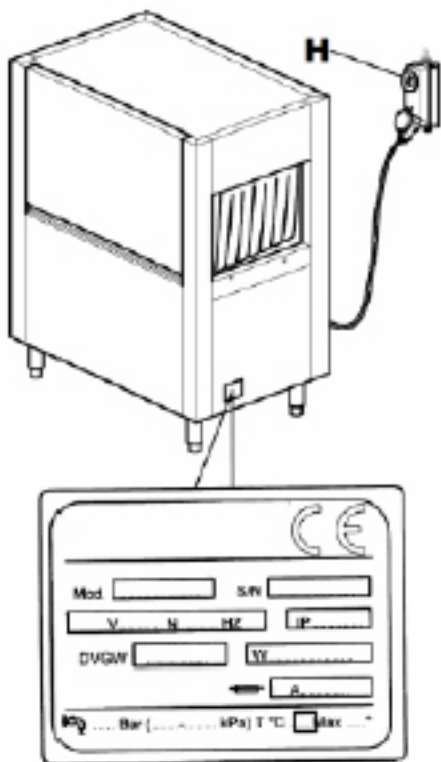

- The appliance must be connected to the mains via an appropriate automatic circuit breaker for all phases, type "C", according to the applicable safety standards, or via a fused circuit breaker with a minimum distance of 3 mm between disconnected contacts. This switch is not supplied with the appliance and must be installed on the wall in an easily accessible position, at a height of between 0,6 m and 1,70 m.
- Make sure that there is no voltage in the power supply line before connecting to the mains.
- Unscrew the screws and remove the front panel and the electrical box cover.

H07RN-F			
Current (A)	Cross section (mm ²)	Maximum length (mm)	

40	10	5000
50	16	
63	16	
80	25	
100	35	
125	50	



Feed the power cord through the grommet located at the rear of the appliance.

- Connect the cable to the terminals prepared in the cabinet as indicated on the attached wiring diagram.
- Incorrect connection of the neutral and earth cable can cause irreversible damage to the appliance and void the warranty!
- Check cable tightening on contactors, thermal protectors, etc., as the screws may have loosened during transport.
- Reinstall the front cover panel and control panel using the screws provided.
- During normal operation or proper maintenance, the power cord must not be in tension or pinched anywhere.
- In addition, the appliance must be connected to an equipotential system, the connection of which is made by a screw with the appropriate symbol.
- The equipotential bonding wire must have a cross section of 10 mm².

Do not use adapters, multiple outlets, improper cable types and cross-sections, or extension cords that do not comply with applicable installation codes.

Connection to the water supply network

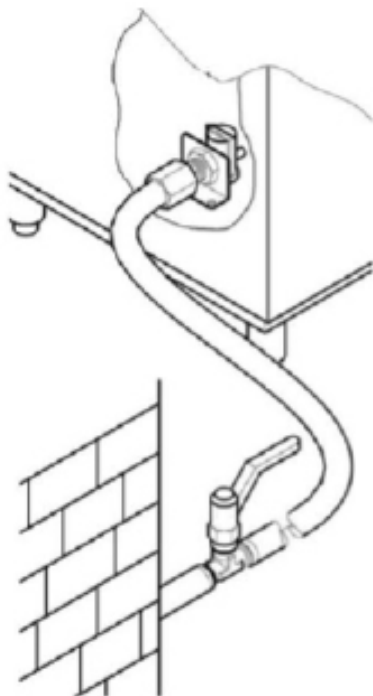

Prepare the room according to the attached installation diagram.

Before connecting the appliance, ensure that a shut-off valve is included between the mains water supply and the appliance to allow the water supply to be shut off in case of need or repairs.

In addition, make sure that the supply quantity is not less than 20 l/min.

Attention!

- Make sure that the temperature and pressure of the feed water correspond stably to the pressure and temperature range indicated on the type plate. Otherwise, it will not be possible to achieve the correct quantity and temperature of the running rinse water.

If the water hardness is higher than the table, we recommend installing a water softener before the inlet

valve to the appliance.

In the case of very high concentrations of mineral residues in high conductivity water, we recommend installing a demineralization device set for the resulting hardness according to the table below.

	Features		Min.	Max.
Hardness	French grades	f	5	10
	German grades	°dH	4	7,5
	English grades	°e	5	9,5
Residual minerals (TDS)	Parts per million (20°C)			
		ppm	70	
		mg/l	70	

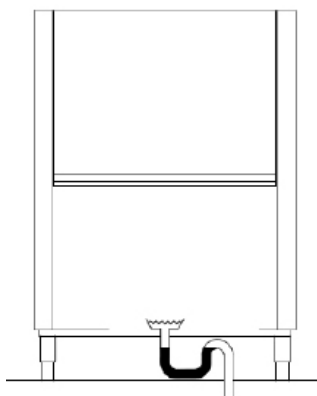

Connecting the washing tub

- Appliances with a pull basket have a continuous operation, so they require very efficient free-flowing waste.
- For the location of the waste from each tub and its dimensions, see the installation diagram included with the appliance.
- Connect the waste from the appliance to the waste network with pipes resistant to a constant temperature of 70°C and, if possible, with the couplings from the equipment.
- The waste system must also have a siphon in the case of waste to the floor, as shown in the figure

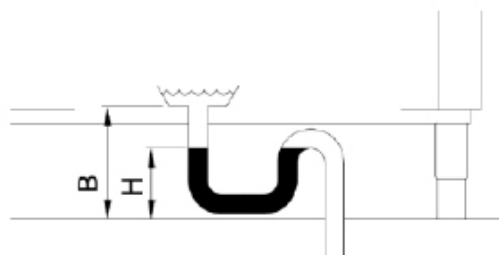
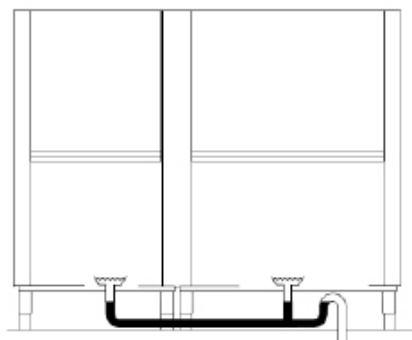

ne waste trap
æed the height B of the

Connecting the washing tub

- Appliances with a pull basket have a continuous operation, so they require very efficient free-flowing waste.
- For the location of the waste from each tub and its dimensions, see the installation diagram included with the appliance.
- Connect the waste from the appliance to the waste network with pipes resistant to a constant temperature of 70°C and, if possible, with the couplings from the equipment.
- The waste system must also have a siphon in the case of waste to the floor, as shown in the figure
- In the case of multiple wash tubs, simply connect them to one waste trap
- The height of the siphon from the ground "H" must not exceed the height B of the outlet as indicated in the figure.

Steam pipe connection (optional)

The appliance develops steam during its operation and it is therefore recommended to install a forced extraction over the appliance

(1500-3000 m³/h)

Alternatively, you can order an appliance equipped with extraction or vapour recycling.

In the latter case, the steam can also be vented directly outside the room, the steam outlet chimney with a suitable stainless steel pipe has a diameter of 250 mm.

Attention!

- The dryer module chimney is used to cover the motor housing and does not need to be connected to any piping.
- Do not fully supply water to appliances equipped with copper-piped heat recovery units demineralized. In such cases, request a version with stainless steel demineralising taps.

Connecting the limit switch

Installation of a limit switch is **REQUIRED** for the appliance to operate.

The limit switch must be mounted on the outlet surface.

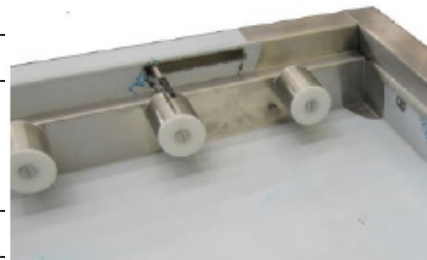

The switch must be adapted to the application

Limit switch with lever control

Design to increase the contact area and dampen the effect of mechanical

Use on all baskets used in the room.

Protection of at least IP55

Normal mode (opening contact)

Output of 240 V, 1.5 A

Life of 10 000 K cycles.



Installation of dispensers

The appliance has specific outlets for the detergent and rinse aid dispensers; connect the dispensers as indicated on the wiring diagram to ensure proper operation of the appliance.

Dosing of detergent and rinse aid must be done via automatic dispensers.

The quantity of products is determined by the installer depending on the hardness of the water; the technician will also perform the calibration

dispensers.

For the first filling of the dosing circuit and for the relevant adjustments, read the section "Adjustments".

- The level of liquids in the tanks must never drop completely.
- Aggressive or impure products must never be refilled.
- It is prohibited to use chlorine-based products that promote the formation of chlorides, which at concentrations greater than 50 ppm can cause corrosion
- Manual dosing of products is not recommended.
- For any other installation, see the attached electrical and wiring diagrams
- The appliance does not support multi-voltage dispensers and/or dispensers with an input power greater than 5 A per output.

If you want to use this type of dispenser, it must be connected to an external 16 A relay

The use of detergents containing chlorides in concentrations higher than 50 ppm may cause corrosion of the stainless steel from which the appliance is made.

Installation of anti-splash curtains

The appliance is equipped with anti-splash hinges to separate the different sections of the appliance.

See Figure 19 for the installation diagram.

8. INSTRUCTIONS FOR USE

COMMISSIONING

First filling of the heater

Link to figure 2

- Open the water inlet gate valve (Fig. 2/A)
- Switch on the power supply using the main switch (Fig. 2/B)
- The guidance button (1) lights up red (Fig. 2/C)
- Press the lead button (1) to switch on the appliance (Fig. 2/C)
- The guidance button (1) turns green and the icons for the different selectable languages appear on the display (Fig. 2/D)
- Press the desired language icon directly on the display (Fig. 2/E)
- The icon of the selected language is highlighted in the frame and appears on the display (Fig. 2/E)
- Confirm the selection by pressing the Exit icon (Fig. 2/F)
- Select the water supply temperature by selecting from the menu below (fig. 2/G)



Cold water (10 °C → 50 °C)



Hot water (50 °C → 65 °C)

- Press the confirmation icon to activate the process of filling the heater (and dispensers if available), press

the X button to cancel the process (Fig. 2/H)

- The appliance automatically starts filling the heater (and dispensers, if installed) and displays the elapsed and remaining time on the display (Fig. 2/I)
- When the display shows the message that the heater has been successfully filled, press the confirmation button; the appliance is ready to be switched on (to cancel the filling process, press the "X" button) (Fig. 2/L)

Controls

Check that the water level in the wash tub is 1-2 cm below the overflow level after filling.

- Check that the temperature of the wash and rinse tray corresponds to the setting.
- Check the operation of the dispensers.
- Check the correct function of the rinse saver: it must start to discharge hot water when the basket reaches below the rinse nozzles and stop when the basket comes out.
- Check the function of the appliance limit switch, which must block the feed motor and pump when the basket reaches the end of the table. Operation is restored by removing the basket.
- Check the direction of rotation of the pumps. If they rotate in the opposite direction, reconnect the two pha-

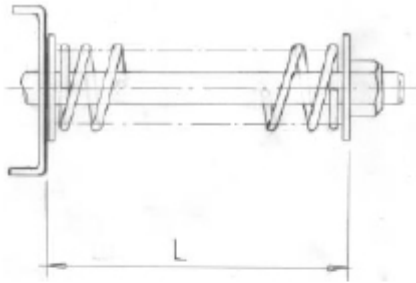

Check the settings of the mechanical safety system of the conveyor, which must be adjusted to take into account the overall length of the appliance and the output tables.

A full load of baskets filled with dishes must not block the movement of the conveyor.

The adjustment is made by means of a screw on the bracket that carries the conveyor displacement unit.

The recommended length "L" must be between a minimum of 60 and a maximum of 75 mm

(see picture)

For complex configurations, please contact the service centre.

- Check that the direction of rotation corresponds to the illustration and the markings on the central conveyor shift.



WARNING: In case of wrong direction of rotation, the mechanical to ensure the shift is ineffective.

Failure to carry out these checks automatically voids the warranty.

AFTER INSTALLATION

- The installer is required to inform the manufacturer of any operational and/or safety defects that occurred during the first test.
- The appliance can only be used after the installation has been completed.
- The technician must issue a declaration of work carried out in accordance with the professional requirements and in accordance with the applicable legislation.

Appliance dia-



- 1 Pre-wash chamber
- 2 Wash tub
- 3 Pre-rinse chamber
- 4 First rinse chamber
- 5 Final rinse chamber
- 6 Drying chamber
- 7 Steam extraction and recovery area
- 8 Pre-washing bath
- 9 Wash tub
- 10 Rinse tub
- 11 Heater
- 12 Heater

Continuous washers with a drift basket are made of high quality materials, the construction of the wash tubs

is AISI 304 stainless steel and the remaining parts are stainless steel.

- The first coarse washing of the dishes is carried out in pre-wash section 1.
- In section 2 for washing, the washing of dishes is carried out.
- In section 3, 4, 5 a rinse is performed.
- In section 6, drying of dishes is carried out.
- In section 7, vapour extraction or heat recovery is carried out.
- The baskets are moved automatically through the individual sections by means of a side pulling device.

Dangerous places

A hazardous location or hazardous area of an appliance is a zone where an accident can occur if the instructions below are not followed.

- If the conveyor stops during normal operation, press the power button.
- Restart the appliance only after checking and removing the cause of the blockage.
- Access from the inlet and outlet of the towing device inside a switched on and moving appliance is very dangerous and is therefore prohibited.
- It is very dangerous to carry out repairs to the conveyor system and electrical users while the appliance is running and is therefore prohibited.
- It is forbidden to use the appliance without supervision.
- Do not immerse your hands in the bath water.
- Pressing the switch to deactivate or activate the appliance with wet hands is prohibited.
- It is strictly forbidden to open the electrical cabinet.

Safety equipment

- Magnetic switches are mounted on the door to interrupt the pre-wash, wash, rinse and basket shift functions when opened.
- Protection against accidental start-up. In the event that the appliance stops accidentally due to a power failure, its function will not automatically resume when the power supply is restored.
- Thermal protectors for electric pumps and motors that guarantee their integrity in the event of short circuits and overloads.
- Magneto-thermal protection and/or fuses for each heating element to guarantee protection against short circuit and overload.
- Heater safety thermostat. In the event of a failure of the temperature control thermostat, a second safety thermostat intervenes to interrupt the operation of the heating elements.
- Conveyor safety microswitch. If the conveyor stops due to accidental causes, a microswitch located near the motor reducer bracket interrupts the shift function.
- Door safety latch. When the door is opened, the hooks prevent the door from falling if the spring breaks.
- Low voltage control.

Regulatory use

- Continuous washers with a drift basket have been specially designed for washing plates, glasses, cups, cutlery and so on together with the basket in which they are stored. Any other use does not comply with the regulations.
- The manufacturer's safety, working and maintenance regulations must be observed.
- The relevant accident prevention regulations and other recognised technical safety regulations must be observed.
- The appliance may only be used by persons who have been adequately trained in the potential hazards.
- The appliance may only be used with original accessories and spare parts from the manufacturer.

USE OF THE MACHINE

Description of controls

1	ON/OFF BUTTON	3	INFORMATION DISPLAY
2	START/STOP BUTTON	4	EMERGENCY SWITCH
5	BLOCKED INDICATOR LIGHT TOUCH SCREEN	6	LEAD INDICATOR LIGHT ON/OFF

7	ON-VOLTAGE INDICATOR LIGHT	8	LOCK SELECTOR TOUCH SCREEN
---	----------------------------	---	----------------------------

Switching on the appliance

Link to figure 2 and 3

- Open the water inlet gate valve (Fig. 2/A)
- Switch on the power supply using the main switch (Fig. 2/B)
- The guidance button (1) lights up red and the system files are displayed (fig. 3/A1)
- Reset the emergency switch (4), if activated, by turning it clockwise.
- Press the power button (1) to switch on the appliance. (Fig. 2/C)
- The guidance button (1) turns green and the button (2) turns yellow.
- The appliance starts to fill with water and the display shows an animated tap icon and the message "Please wait" (Fig. 3/A)
- When the correct level is reached, the display alternates between "Press Start" and "Insert basket". (Figure 3/B)

Heating

Link to figure 4

- After filling with water, the appliance automatically starts heating
- During heating, an animated thermometer icon appears on the display (Fig. 4/A)
- When the set temperatures are reached, the button (2) will light up green (fig. 4/B)

Washing

Link to figure 4

- To start washing, simply insert the basket into the inlet of the washer until it connects to the basket drift system, or you can press the button (2)
- The message "Active wash" appears on the display.
- During washing, the display shows an animated icon of the dishwasher basket (Fig. 4/C)

Washing programmes

Link to Figure 5

- Press the button on the bottom right of the display to open the wash programme selection menu (Fig. 5/A)
- Press the desired program icon directly on the display (Fig. 5/B)
- The icon of the selected programme is highlighted in the frame and appears on the display
- Confirm your choice by pressing the exit button (Fig. 5/C).
- During washing, you can only select a different programme by pressing the button (2).
- You can choose from the following programmes:



P1
High capacity
Suitable for light fresh dirt.



P2
General washing
program for general use

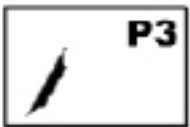

P3
Long contact
ensures a contact time of 120" according to DIN 10534.



P4
Glasses
When this program is selected, the corresponding system is automatically triggered, which reduces the heater temperature to 65 °C once the first basket of glasses has passed under the rinse. No waiting time. (requires the use of suitable baskets 50x50 cm)

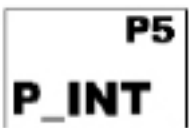

P5
P_INT
Intense
for stubborn dirt with a washing temperature of 63 °C.

Stopping device

The appliance is equipped with an emergency switch (4) on the control panel and its activation causes an immediate stop of all moving parts and the washing programme.

Additional optional stacking devices can be installed near the inlet and outlet of the baskets.

Temperature display

Link to Fig. 6

The wash and rinse temperature can be displayed at any time.

During washing, simply press the box on the right of the display (Fig. 6/A)

The display shows the water temperature for the main wash "W2", the top rinse "B1" and the bottom rinse "B2"

To hide the message, press the checkbox again.

Limit switch

The appliance may only operate with the limit switch installed on the outlet surface of the baskets (see chapter Installation).

As soon as the basket coming out of the appliance reaches the end of the table, the message "Limit switch

ZAP" and the  icon and scrolling will stop until the bin is removed.

To completely restart the appliance, simply remove the basket from the end of the table.

If you do not remove the basket within a few minutes, the dishwasher switches off the rinse, wash, pre-wash and finally

and drying, if installed.

Switching off and standby mode of the appliance

Link to figure 1

To switch off the appliance, press the control button (1), which turns red.

The display stays on for a few minutes and then switches off completely.

In standby mode, you can lock the display by pressing the  button and reactivate it

press .

This last function allows you to clean the display surface.

Adjustment



The user can set temperatures and dosing times.

Referring to Figure 7



- Enter the adjustment menu by pressing the  icon (fig.7/A)

- Press the  icon to access the adjustment menu (Fig. 7/B)

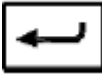
- You will be prompted to enter your password for  access.

- Enter "0" "1" "2" using the   buttons to change the number. Use the  button to go to next issue.

- You can now scroll through all temperature settings using the arrows.

- To change the displayed parameter it is necessary to press the menu button  (the setting box will be highlighted), and then it is possible to set the desired value using the buttons  

- Changes cannot be made during washing.

Temperatures

Our settings are optimal and guarantee the best result in terms of cleaning results, performance and consumption.

In case of special requirements, the temperature parameters set by the manufacturer can be adjusted within the adjustment range shown below.

Program	MYTH	SETTINGS From produc- tion	Adjustment range (°C)	
High capacity	P1 -Washing tub plates	63	Min. 0	Max. 70
General washing	P2 -Washing tub plates	60		
Long contact	P3 -Washing tub plates	60		
Intense	P4 -Washing tub plates	63		
Glasses	P5 -Washing tub plates	60		

Program	OPLACH	SETTINGS From produc- tion	Adjustment range (°C)	
High capacity	P1 -Heater rinse temperatures 1	82	Min. 0	Max. 90
General washing	P2 -Heater rinse temperatures 1	82		
Long contact	P3 -Heater rinse temperatures 1	82		
Intense	P4 -Heater rinse temperatures 1	82		
Glasses	P5 -Heater rinse temperatures 1	65		
High capacity	P1 -Rinsing heater 2	80		
General washing	P2 -Rinsing heater 2	80		
Long contact	P3 -Rinsing heater 2	80		
Intense	P4 -Rinsing heater 2	80		
Glasses	P5 -Rinsing heater 2	65		

Program	SUBJECT	SETTINGS From produc- tion	Adjustment range (°C)	
	Prewash temperatures min	40	Min. 0	Max. 60
	Prewash temperatures max	50		

Program	SUBJECT	SETTINGS From produc- tion	Adjustment range (°C)	
	Prewash temperatures min	40	Min. 0	Max. 60
	Prewash temperatures max	50		

Program	DRYING	SETTINGS From produc- tion	Adjustment range (°C)	
	Drying temperature	85	Min. 0	Max. 100

Program	WASHING 3. BATH	SETTINGS From produc- tion	Adjustment range (°C)	
	Tank Temperatures 1 (if available)	60	Min. 0	Max. 70
Program	SOURCE	SETTINGS From produc- tion	Adjustment range (°C)	
	Supply water temperature alarm	10	Min. 0	Max. 65

Dispensers

Adjustable dosing time in seconds for detergent and rinse aid dispensers.

	DETERGENT	SETTINGS From produc- tion	Adjustment range (°C)	
	Detergent settings	4	Min. 0	Max. 25
	PAGE	SETTINGS From produc- tion	Adjustment range (°C)	
	Setting the polish	3	Min. 0	Max. 25

The dosing circuit can be filled manually.

Select (using the Menu button) the "Manual activation of the detergent dispenser" and/or "Manual activation of the rinse aid dispenser", then activate the function with a lightm by pressing one of the two buttons



or

and the corresponding dispenser will start filling the circuit for a predetermined time; if it is not enough to fill the entire circuit, press the button again.

Time and date settings

Link to Figure 8 and 7



Enter the adjustment menu by pressing the  icon (fig.7/A)



- Press the  button to access the adjustment menu (Fig. 8/A)



- Press the Enter button 

- Use the arrow keys to change the hours, minutes, year, month and day  , confirm again with

Enter 

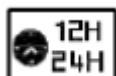

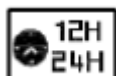
By pressing the  button you can change the time format,

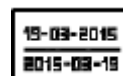

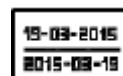
by pressing the  button you can change the date.

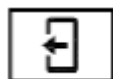

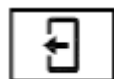

To return to the previous menu, press the Exit button .

Clock settings

Link to figure 2 and 7

Enter the adjustment menu by pressing the  icon (fig.7/A)

- Press , open the language selection menu and select the desired language (Fig. 2/E)



- Press the Exit button  to confirm your selection and return to the previous menu.



Setting the display brightness and beeps

Link to Figure 7 and 9

Enter the adjustment menu by pressing the  icon (Fig.7/A).

Press the  button (Fig. 9/A).

Adjust the brightness of the display using the two   buttons (Fig. 9/B).

Activate or deactivate the acoustic signal using the  button to turn it off and the  button to turn it on, then press the Exit button to confirm the selection and return to the previous menu

System information

Link to Figure 7

You can view the installed firmware version at any time.

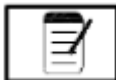
Enter the adjustment menu by pressing the  icon (Fig.7/A).

Press the  button to access the firmware version screen.

Press  to exit.

Connectivity

The appliance is designed for remote control via wireless transmission.

The  symbol on the display indicates whether or not the device is connected to a wireless network

The  symbol indicates that the appliance is connected.

The  symbol indicates that the appliance is disconnected.



To access the wireless network setup section, press the  button (Figure 7/A), and then the

button to find out whether the device is connected to the network or not.

For more information, please refer to the manual included in the optional wireless kit

Offer Information

Link to Figure 10

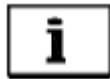

Press the "Info" button  to enter the information menu, from which you can get precise information

error messages, operating hours and main operating parameters (Figures 10/A and 10/B), which are described below.

Error messages

Link to Figure 11

The appliance is equipped with a self-diagnostic system and can report one or more error messages to the user.





Press the  button from the "Info" menu to display the last error found (Fig. 11/A and 11/B)

To find out the meaning of the displayed error message, read the paragraph "Self-diagnosis"



To find out the date and time of the event, press  (Fig. 11/B)





To scroll through the error messages, press , to exit the menu press 

Operating hours display

Link to figure 12





Press the  button to view partial and total wash and rinse hours

By scrolling through the buttons  and , the partial and total wash and rinse times are displayed in turn

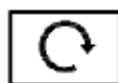
and the total start-up time of the appliance.

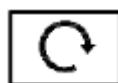

The sub counters can be reset by pressing the  button and confirming with the  confir-

mation button or canceling with the 



To exit the menu, press the Exit button

Display of operating functions

Link to Figure 13.

The appliance offers the possibility to view some operating parameters in detail by pressing the button



(fig.13/A)

By pressing the  button (fig.13/B-G) you can scroll through the different parts of the menu, to return to the previous









menu, press the Exit button (Fig. 13/H).

For each section, the following current operating temperatures will be listed:

- Supply water temperature
- Water temperature of both heaters
- Water temperature in the bath before washing
- Water temperature in the first wash tub, and in the second wash tub if available
- Drying air temperature

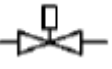
In addition, for each section, animated icons provide additional information, such as:

- When the heating elements are on, the thermometer icon flashes .
- If the appliance is filling with water, the tap icon shows running water .
- If drying is switched on, the air flow is displayed .
- The correct water level in the bath is indicated by the arrow .
- The opening of the electromagnetic rinse valves is indicated by a flashing icon .
- The operation of the rinse pump is indicated by a flashing icon .

Mechanical control panel

Link to figure 1

The appliance has an additional panel located at the outlet of the baskets from the appliance, on which some basic controls and indicator lights.

Electrical power indicator light

Link to Fig. 1

The indicator light (7) indicates that the appliance is electrically powered and is on as long as the wall switch is on in the ON position.

Disabling the touchscreen

Link to Figure 1 and 5B

Turn the selector dial (8) clockwise to disable the touch keypad.

The display (3) will continue to show the appliance parameters, but can no longer be used.

This status is indicated by the continuous illumination of the indicator light (5) and the display of the icon



on the display.

To reactivate the use of the display, simply turn the dial (8) anti-clockwise.

ON/OFF button

Link to figure 1

In a locked touchscreen state (see previous paragraph), the appliance can be switched off and on at any time

press the button (6).

When the dishwasher is switched on again, it will start at that point and with the previously saved washing programme.

AUTODIAGNOSTICS

The appliance is equipped with a self-diagnostic system and is capable of detecting and signalling a wide range of faults.

Failure	Description and possible solutions
Er01	No rinse. The surface rinse did not take place correctly. Check that the rinse nozzles are clean.
Er02	No water was released. The water is not draining, or it's not draining properly. Check to see if the drain hose is bent or not properly connected, or if the siphon or filters are clogged. For appliances equipped with an overflow, the overflow must be removed before starting the drain cycle.
Er03	Failure to restore rinse temperature. Heater temperature reset did not occur at the predetermined time during the wash cycle. Turn the appliance off and then back on and perform a new cycle.
Er04	Failure of water filling into the tank. Make sure all water connections are well connected and the tap is open. If there is an overflow in the washer, check that it is in place. Turn the appliance off, then back on, and try filling it again.
Er05	Tank thermometer malfunction. (Sensor disconnected) The appliance does not detect the temperature value in the tank. Switch the appliance off and then on again.
Er06	Tank thermometer malfunction (sensor short circuit) The appliance does not detect the temperature value in the tank. Switch the appliance off and then on again.
Er07	Boiler thermometer malfunction. (Sensor disconnected) The appliance does not detect the boiler temperature value. Switch the appliance off and then on again.
Er08	Boiler thermometer malfunction. (Sensor short circuit) The appliance does not detect the boiler temperature value. Switch the appliance off and then on again.
Er09	Boiler filling time delay: the boiler is not filling. It is not possible to rinse. Check that the tap is open. Switch the appliance off, then on again, and carry out a new cycle.
Er21	Rinsing insufficient, rinsing not done in the right quantity. Check that the rinsing nozzles have been cleaned correctly. The appliance does not stop when an error is reported.
Er22	Tank temperature reset failure: the tank temperature reset did not occur at a predetermined time during the wash cycle. Turn the appliance off and then back on and perform a new cycle.
Er25	Performing external regeneration: the number of litres set for the external water treatment device has been reached, the error does not hinder the operation of the dishwasher, the message can be removed in menu setting 12.

ErSF	Electromechanical protection: the safety thermostats of the boiler or tank have been affected or the safety pressure switch for the tank level has been affected.
ErSL	Securing the level: Incorrect water level in the bathtub.
Coat of arms	Excessive boiler temperature: probable heating relay/ contactor failure.
Ert	Excessive tank temperature: probable failure of the relay/heater contactor.
drt	Clogged filter: improper water level in the bathtub caused by a dirty filter or an improperly inserted overflow.

Failure	Description and possible solutions
ErSI	Input security error: Irreversible error, contact Technical Assistance.
Er98	Soft start, I think: Error in the soft start system, contact Technical Assistance.
NO SALT	Lack of salt: in dishwashers with a softener, this indicates a lack of salt. Add salt.
NO DT	Lack of cleaning agent: Add detergent to the filling tank.
NO BL	Lack of polish: Add polish to the filling tank.
SERV	Maintenance Requirement: Routine maintenance is required if preset.
REG ON	Regeneration in progress: the water softener resin regeneration cycle is in progress.
REG REQ	Regeneration requirement: regeneration must be running if it is not automatically scheduled.
Er27	Boiler gradient error: the boiler heating is not working properly.
Er28	Tank gradient error: tank heating is not working properly.
Er99	Auxiliary card error: communication with the auxiliary card is not working properly.
Er30	Auto-opening error: on hood washers with automatic opening, the opening system is not working properly. Make sure that there is nothing obstructing the opening of the bonnet. If the problem persists, call a service centre.
Er31	Auto-close mode: on hood washers with automatic opening, the closing system does not work properly. Make sure that nothing obstructs the closing of the bonnet. If the problem persists, call a service centre.
Er33	Osmosis with minimum pressure: Make sure the water tap is open.
Er34	Osmosis water leak: close the electricity and water supply to the dishwasher, contact technical support.
Er35	Osmosis conductivity error: the system is not working properly, contact technical support.
Er36	Osmosis filter: the osmosis filter needs to be replaced, contact technical support.
Er37	Boiler heating timeout: the rinse water heater is not working properly, contact technical support.
Er38	Tank heating time limit: The wash water heating element is not working properly, contact technical support.
Er39	Boiler pressure switch failure.
Er40	Failure of the tank pressure switch.
Switching the appliance off and then on will "reset" the alarm; if the problem persists after following these instructions, contact an authorised service centre.	

Recommendation:

- Do not put silverware and stainless steel cutlery in the same basket, as the silver will tarnish and the steel may corrode.
- Always use specific specially designed baskets for different types of dishes (plates, glasses, cups, cutlery, trays, etc.) Fig. 14.
- To save detergent and electricity, wash only complete baskets, but without overloading them.
- Do not put the dishes over each other.
- Keep dishwasher maintenance to a minimum. We therefore recommend pre-cleaning dishes to remove food residues such as fruit peelings, toothpicks, olive pits, etc, this could partially clog the electric pump filter and reduce the washing efficiency and the quality of the end result.
- It is recommended to wash the dishes before they can dry out. In case of hardened dirt, it is advisable to let the dishes and cutlery soak before putting them in the dishwasher
- Always choose the washing programme and/or speed most suitable for the type of items to be washed

- Always wash the glasses with clean washing water and preferably at the beginning of the shift or after a water change.

Use the glass cycle that is on some models of dishwasher.

- Use only baskets with dividers and water with a conductivity of less than 80 µS to wash crystal glasses
- If the dishwasher has a pre-wash in the corner section, the trays must be loaded with the part possibly protruding from the basket facing the direction of travel, see Fig. 16
- The appliance is not designed for predominant and continuous washing of large objects. However, it is possible to wash them alternately with other dishes and using baskets with possible dividers for baking dishes.
- The appliance is not designed for washing baskets.
- Incorrect arrangement of dishes or washing large items for which the dishwasher was not designed, may cause abnormal leakage of water into the drains, resulting in partial emptying of the tubs. In this case, the appliance will automatically stop and refill the water to the correct level. This could happen more frequently during operation.
- The baskets must be of a type suitable for the conveyor system of the washer and must be in good condition, especially at the bottom. Use the baskets supplied as a model.
- In the case of appliances with corner drying, the trays must be placed in the appropriate basket, omitting one, as in Figure 15
- Baskets 50x60 cm cannot be used.

mAINTENANCE

The appliances are designed to keep maintenance requirements to a minimum. The following rules shall apply

to be observed in all cases to guarantee a long service life and trouble-free operation.

In any case, some general principles must be followed to keep the washers running properly:

- keep the appliance clean and tidy
- prevent makeshift or emergency repairs from becoming the norm

Strict adherence to periodic maintenance rules is extremely important; all parts of the appliance must be checked regularly to avoid any malfunctions and downtime required to carry out any maintenance.

Attention!

- Disconnect the appliance from the mains before cleaning
- Before cleaning, wear gloves with a minimum of 3 cut protection according to EN388.
- The use of appliance cleaners containing chlorides in concentrations greater than 50 ppm may cause corrosion of the stainless steel from which the appliance is made.

Regular maintenance

With reference to Figure 18

Attention!

Before cleaning, wear gloves with a minimum of 3 cut protection according to EN388.

- Remove the upper and lower rinsing arms.
- Clean all nozzles of dirt and return them to their place.
- Remove the hinges and clean them under running water with a nylon brush.

- Remove the upper and lower wash arms, clean and rinse them.
- Remove the wash pump filter, clean and rinse it.
- Then clean the wash tank thoroughly.
- Due to calcium and magnesium salts from the water, after a certain period of operation, which varies depending on the hardness of the water, the calcium deposits on the internal surfaces of the heater bath and pipes, which may affect the operation of the appliance.
- It is therefore necessary to ensure regular descaling, which should be carried out by technically qualified personnel.
- If you do not use the appliance for a long time, oil the steel surfaces with petroleum jelly.
- If freezing is imminent, drain all water from the heater and pump.
- If thick limescale deposits appear inside the water appliance, they can be removed using a product suitable for descaling.
- Carefully follow the product manufacturer's instructions or consult qualified personnel when removing limescale. In any case, rinse the appliance thoroughly after descaling.
- Check the effectiveness of the safety devices.
- If the steam condensation battery is dirty, disassemble it and clean the grooves with compressed air.

REMINDER:

Every mechanical and electromechanical part of the appliance is always subject to physical wear and tear, so it is mandatory that a qualified technician regularly inspects it:

- Conveyor system lock
- Electric wash/rinse pump seal
- Rails and door springs
- Contactors
- Safety equipment

It is also mandatory to test and inspect devices that are not part of the appliance, such as: proper operation of the grounding differential, good ground leakage, automatic transfer switches and/or power line fuses., each electrical conductor, condition of water pipes, drainage system, proper operation of any dispensers.

- In the event of a malfunction or malfunction, contact only a technical assistance centre authorised by the manufacturer or dealer of the equipment.

9. CLEANING AND MAINTENANCE

It is recommended to have the device checked with a specialist service at least once a year. All the interventions in the device can only be carried out by a qualified person who has the authorization to do so.

CAUTION! The device must not be cleaned with direct or pressure water. Clean the equipment daily. Daily maintenance extends the life and efficiency of the equipment. Always turn off the main inlet to the device. Wash the stainless steel parts with a damp cloth with a detergent without coarse particles and wipe dry. Do not use abrasive or corrosive cleaning agents. Attention! Before using the device, it is necessary to remove the protective foil from the entire surface, and then wash it well with water with detergent, and then wipe it with a damp cloth. **ALERT!** The warranty does not apply to all consumables subject to normal wear (rubber seals, bulbs, glass and plastic parts, etc.). The warranty also does not apply to the device if the installation is not carried out in accordance with the instructions - an authorized worker according to the corresponding standards and if the equipment was unprofessionally manipulated (interventions in the internal equipment, etc.) or were operated by unhappy staff and contrary to the instructions for use, further The warranty does not apply to damage by natural effects or other external intervention. **Required service organization 2 times a year. After the lifetime, the shipping packaging and equipment are submitted to the collection, according to the regulations on waste management and hazardous waste.**